



SPARTAN SPZ-WL168
LED Zone 2/21/22 Linear Luminaire
Standard and Emergency variants

rayTEC®



- ATEX and IEC Ex approved – Zone 2/21/22
UL/CSA approved, including C1D2
- Zone 1 variants available
- Emergency variants - up to 100% light output
- Retrofittable
- Ultra long life LED
- High lumen output LED
- Easy installation, maintenance and inspection
- Wide operating temperature range -40° to +60°C
- Clear external tear off strips on outer optics available
- 5 year warranty
- Now 'op is' approved (EN60079-28)

The SPARTAN Linear range is designed specifically for use in new hazardous area installations or to retrofit existing fluorescent installations which require high performance, reliable, White-Light illumination. Housed in Marine Grade aluminium and using Raytec's field-proven, long-life LED technology, SPARTAN Linear is ATEX and IEC Ex approved and dual certified for Zone 2 Gas and Zone 21/22 Dust applications and is rated for T4, T5 and T6 environments (Zone 1 variants also available). SPARTAN Linear's overall dimensions, fixing centres and gland entries are all compatible with commonly used traditional Ex n 2x36W fluorescent luminaires. The lumen output and light distribution also allows a direct, easy replacement of traditional fluorescent luminaires, meaning the customer can upgrade without complication and enjoy all the benefits of long life LED lighting while making regular lamp changes redundant.

SPARTAN Linear is available as an emergency variant, and standard variants can be converted to an emergency fitting at any time on-site, thanks to a unique modular design. This design also means key components can be easily accessed and serviced if required to make inspection and maintenance quicker and easier. SPARTAN Linear has a clear polycarbonate diffuser which is also available in various degrees of opaqueness to provide greater flexibility during installation. SPARTAN uses thermal management technology, ensuring a much cooler LED operating temperature and up to 60% better heat dissipation compared to traditional lighting solutions, allowing the product to operate for > 10 years while still delivering a high lumen output of up to 6,800 lumens.

Product Dimensions

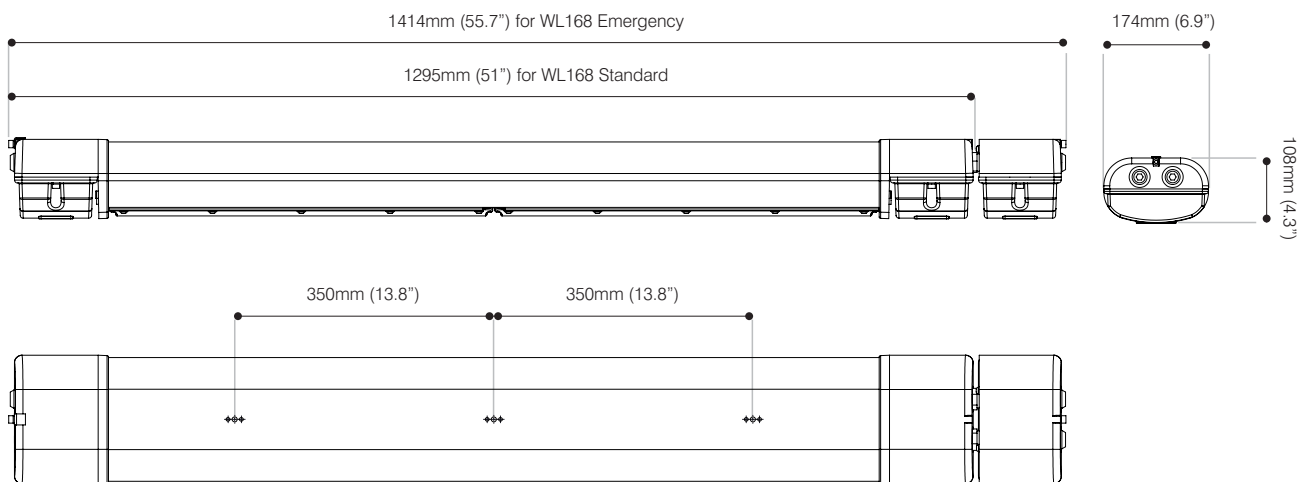

Features

Benefits

Ultra-Powerful	High lumen output – up to 6,800 lumens Latest high power LED technology
Ultra-Flexible	Easy Installation, matching the dimensions of traditional 2x36W fluorescent fittings, to provide an easy direct replacement Equivalent Output to a 2x36W fluorescent
Ultra-Reliable	Industry leading 5 year warranty Designed and manufactured in the UK to the highest standards including both ISO9001 & ISO14001 Advanced electronics and LED's protected by vibration resistant and waterproof potting compound
Ultra-Modular	Both the LED and PSU modules are easily accessible for maintenance and inspection Available as a standard fitting only
Ultra-Efficient	COOLEXTRUDE™ thermal management delivers class leading energy efficiency Significant running and maintenance savings compared to traditional lighting technologies SMART access wiring system for safe and efficient installation, set-up and ongoing inspection
Ultra-Support	Photometric files available (.ies & .ldt) Full Lighting Design Service Site specific Energy and Cost Saving Report available

5 YEAR WARRANTY

All Raytec luminaires are provided with an industry leading 5 year warranty and have an expected useful life in excess of 10 years



Technical Specifications

Certification

ATEX Rating:	ATEX and IEC Ex rated for Gas and Dust
Hazardous Area rating:	Zone 2 – Gas and Dust
Certificates:	CML13ATEX4138 & IEC Ex CML 15.0068 UL/CSA, including C1D2
Gas (Zone 2):	II 3 G D Ex nA mc op is IIC T4 Gc Ta= -40°C to +60°C (-20°C to +50 for emergency variants)
Dust (Zone 22):	Ex tc op is IIIC T80°C Dc Ta= -40°C to +60°C (-20°C to +50°C for emergency variants)
North America Rating:	Class I, Division 2 Groups A, B, C, D, T5 Class II, Division 1 & 2 Groups E, F, G Class III, Division 1 & 2 NEMA 4x, IP66/IP67 UL50E, UL8750, UL 1203 C22.2 No Emergency Variants - Certification Pending
ABS Rating:	ABS Certificate # 15-LD1364539-1-PD

Optical

Lumen output on mains:	Up to 6,800 lm
LED type:	Platinum Elite SMT LEDs
Number of LEDs:	168 LEDs
CRI	80+
Colour Temperature:	6,000K+

Electrical

Input:	110-254V 50/60Hz AC only Low voltage: 18-48V AC and 18-69V DC Extra low voltage: 12V AC/DC
Power:	Standard - 68W Emergency 71W
Termination	Incoming terminal block suitable for looping 4 core 4mm ² cable
Power Factor:	>0.95
Cable Entries	2xM20 as standard (other entries available upon request), dispatched complete with one ATEX/IEC Ex approved blanking plug 3/4" NPT as standard on C1D2

Mechanical/Environmental

Burning position:	Universal
IP rating:	IP66 & IP67
Temperature range:	-40°C to +60°C (-20°C to +50°C for emergency variants)
Weight:	Standard - 9kg (19.8lbs) Emergency - 10kg (22lbs)
Enclosure:	Marine grade aluminium epoxy powder coated, UV stabilised polycarbonate, all external fasteners and brackets are marine grade stainless steel
Unit Colour:	Dark Grey (RAL 7012) Emergency Cover - Red (RAL 3024)
Installation instructions:	Please contact Raytec for copy
Dimensions:	Standard - 1295 x 108 x 174mm (51 x 4.3 x 6.9") Emergency - 1414 x 108 x 174mm (55.7 x 4.3 x 6.9")
Mounting:	Via M8 tapped holes. Various mounting arrangements available (please see product overview guide)
Emergency Duration:	Up to 3hrs @ 25% power Other options available
Emergency Battery:	Ni/Cd 12V
Emergency Time:	20 hours

Part Codes - Zone 2





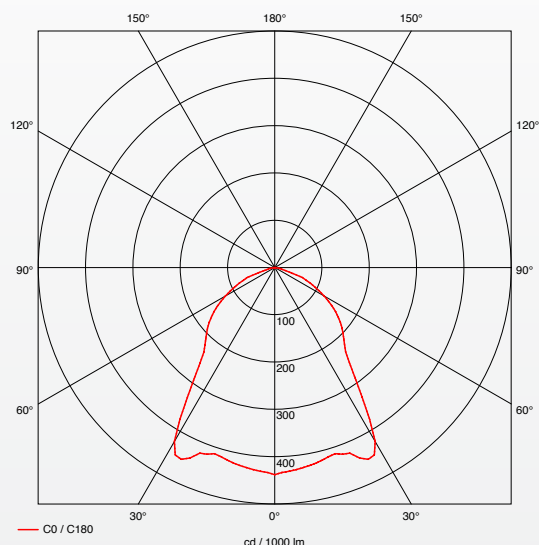

Part Codes	Description
SPZ-WL168	SPARTAN Zone 2 Linear, 168 LED, White-Light
SPZ-WL168-EM25	SPARTAN Zone 2 Linear, 168 LED, White-Light, Emergency Battery Backup

18-69V variants available, add -LV to the above codes
12V variants available, add -ELV to the above codes
Add -D to part code for diffused lens
Add -C1D2 to part code for North American standards
Contact Raytec for T5/T6 variants

Light Distribution



SPARTAN Linear Accessories

 <p>SUSPENSION CORD KIT</p>	 <p>POLE CLAMP KIT</p>	 <p>M8 EYE BOLT</p>
<p>SPX - BKT - SC500 (500mm Long, Stainless Steel) SPX - BKT - SC1000 (1000mm Long, Stainless Steel) SPX - BKT - SC1500 (1500mm Long, Stainless Steel)</p>	<p>SPX - BKT - PC3841 (38-41mm Diameter, Stainless Steel) SPX - BKT - PC4245 (42-45mm Diameter, Stainless Steel) SPX - BKT - PC4851 (48-51mm Diameter, Stainless Steel) SPX - BKT - PC5457 (54-57mm Diameter, Stainless Steel) SPX - BKT - PC5962 (59-62mm Diameter, Stainless Steel)</p>	<p>SPX - BKT - EYE (Stainless Steel)</p>
 <p>CEILING MOUNTING KIT</p>	 <p>SWIVEL MOUNT KIT</p>	 <p>WALL MOUNTING OUTREACH BRACKET</p>
<p>SPX - BKT - CM (Stainless Steel)</p>	<p>SPX=BKT-SW (30° and 45° Increments, Stainless Steel)</p>	<p>SPX - BKT - WMOB84 SPX - BKT - WMOB168</p>

Other accessories also available, including Magnetic Mounting Kit (SPX-BKT-MAG) and Tear Off Optic Strips - pack of 10 (SPX-BKT-PF84)

Products in the SPARTAN Linear range

Zone 1, Zone 2, UL/CSA, Industrial
Emergency variants also available

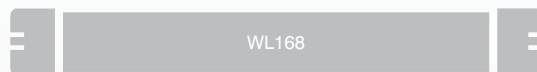

Products in the SPARTAN Family



SPARTAN Flood

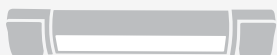

SPARTAN Linear

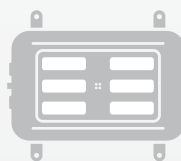

SPARTAN Bulkhead



SPARTAN Bay



SPARTAN Crane