

FDV
LP 14
35 140 03

FAST MOVING PRODUCTS



TEK.DATA

Driver:	Inn: 230V/50Hz Ut: 14W/320mA	Lysspredning: 110° Levetid: 50000t
LED:	14W/320mA	Dimbar: Faseavsnitt/ Triac/DALI
Syst.effekt:	14W	Forkobling: Inkl.
Flux:	991lm	IP-grad: 43
Fargetemp:	3000K	
Ra index:	>80	

MÅL: (mm)

Hulldiameter: 227-230Ø
Diameter: 240Ø
Høyde: 13

MATERIALE

Base: Aluminium
Avskjerming: Hvit Opal PMMA

FORPAKNING ANTALL

Eske: 1
Grossist forpakning: -

ILLUSTRASJONER:

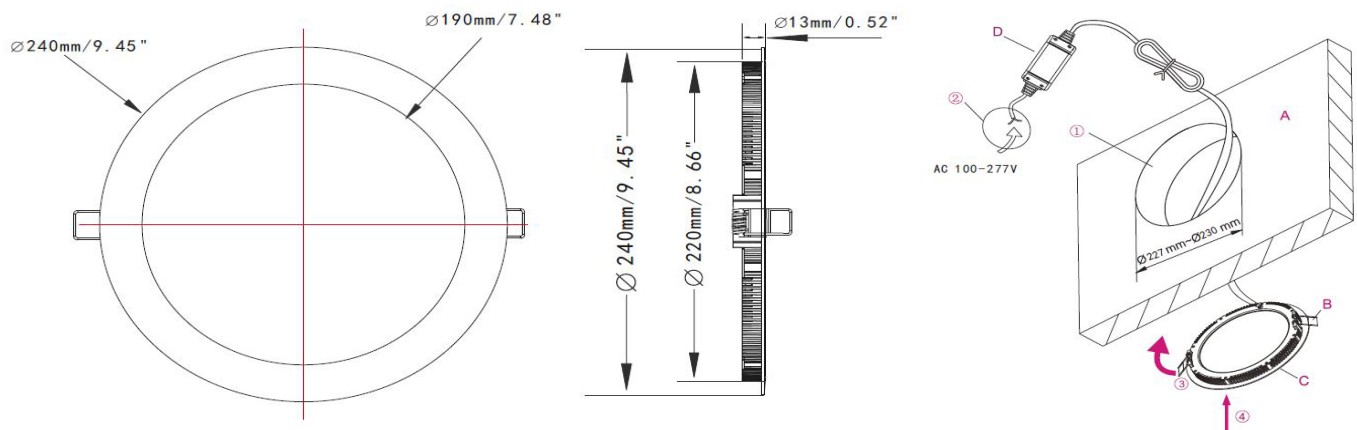

FMP AS Dikeveien 36 1661 Rolvsøy

salg@fmp-as.no www.fmp-as.no

Martin 99 69 28 62

Ole 40 21 40 86

FAST MOVING
PRODUCTS

